

SBSCO Future Wall System

شركة المشغولات والمباني المعدنية المحدودة
Steel Building & Structure Co. Ltd.

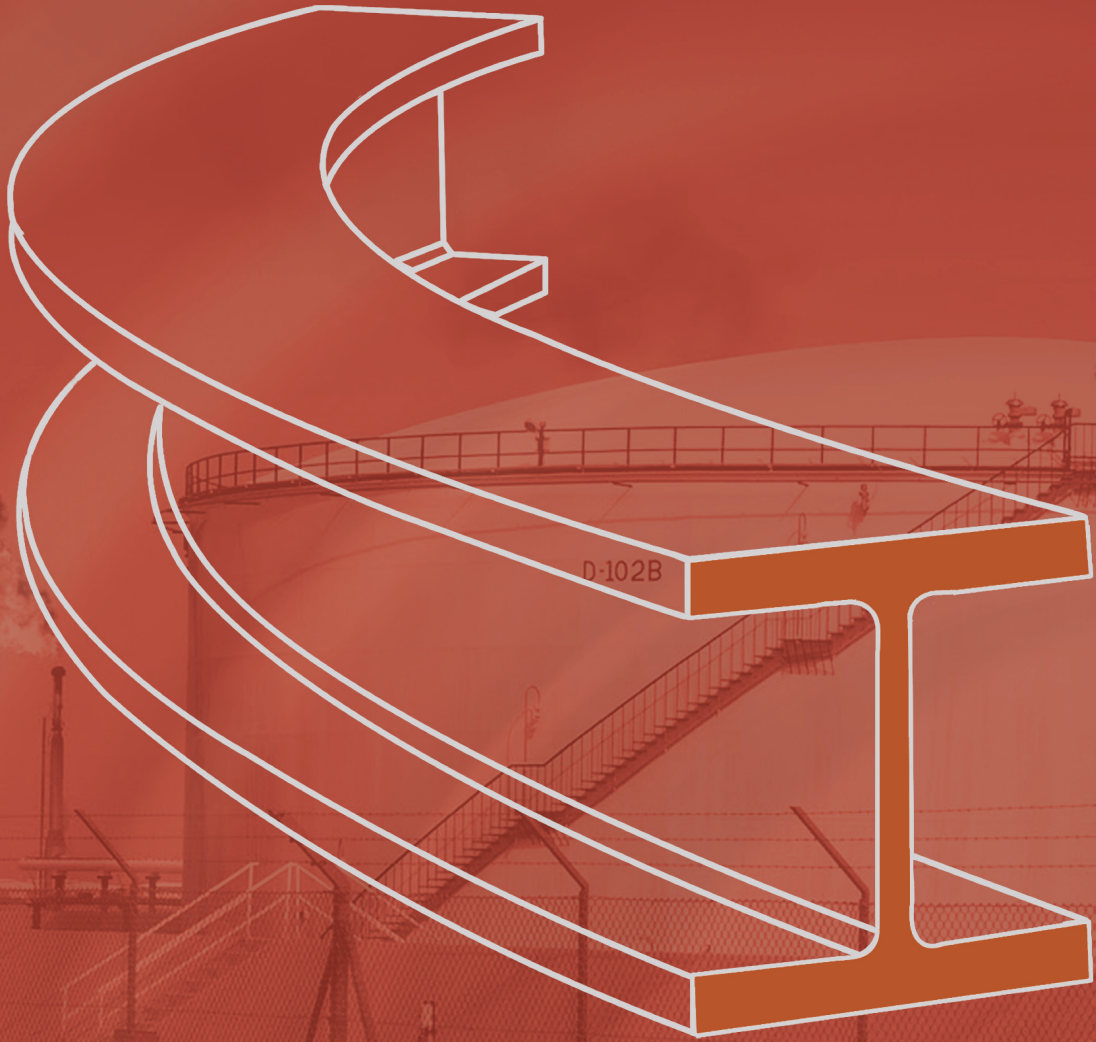

SBSCO Industrial Services

سبسكو للخدمات الصناعية





شركة المشغولات والمباني المعدنية المحدودة
STEEL BUILDING & STRUCTURE CO. LTD.

شركة ذات مسؤولية محدودة رأس المال 1.5 مليون ريال سعودي
Dammam 34331 - 4199 - Building No. 7083 - Second Industrial Area
Intersection Street 85 with 150 - Kingdom Of Saudi Arabia
CR. 2050105307 - CC. NO. 175564



+966 13 832 3388 +966 13 832 9933 alabuo@alabuo.co www.alabuo.co



System Detailing

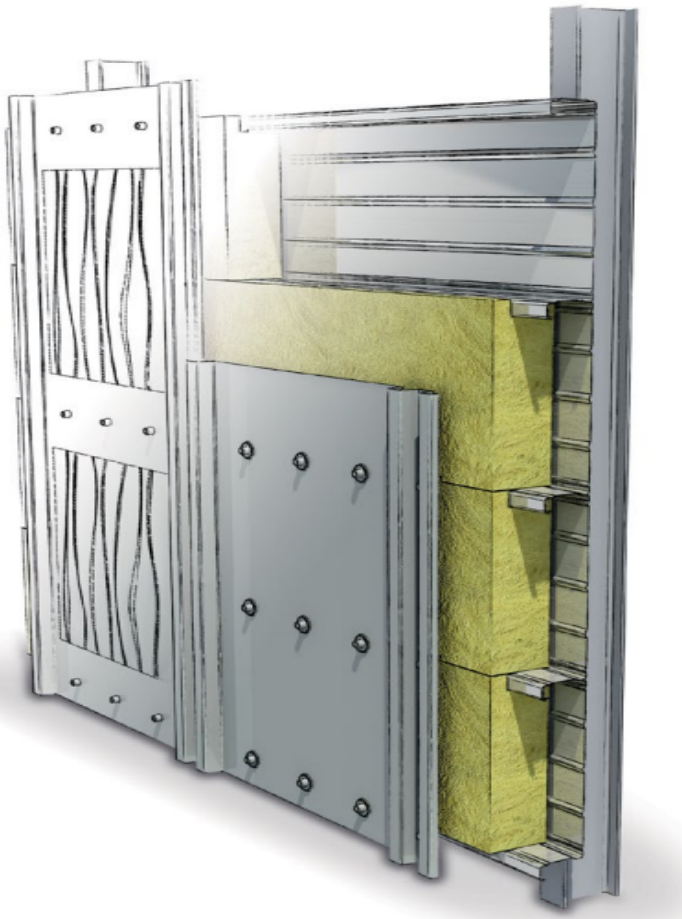
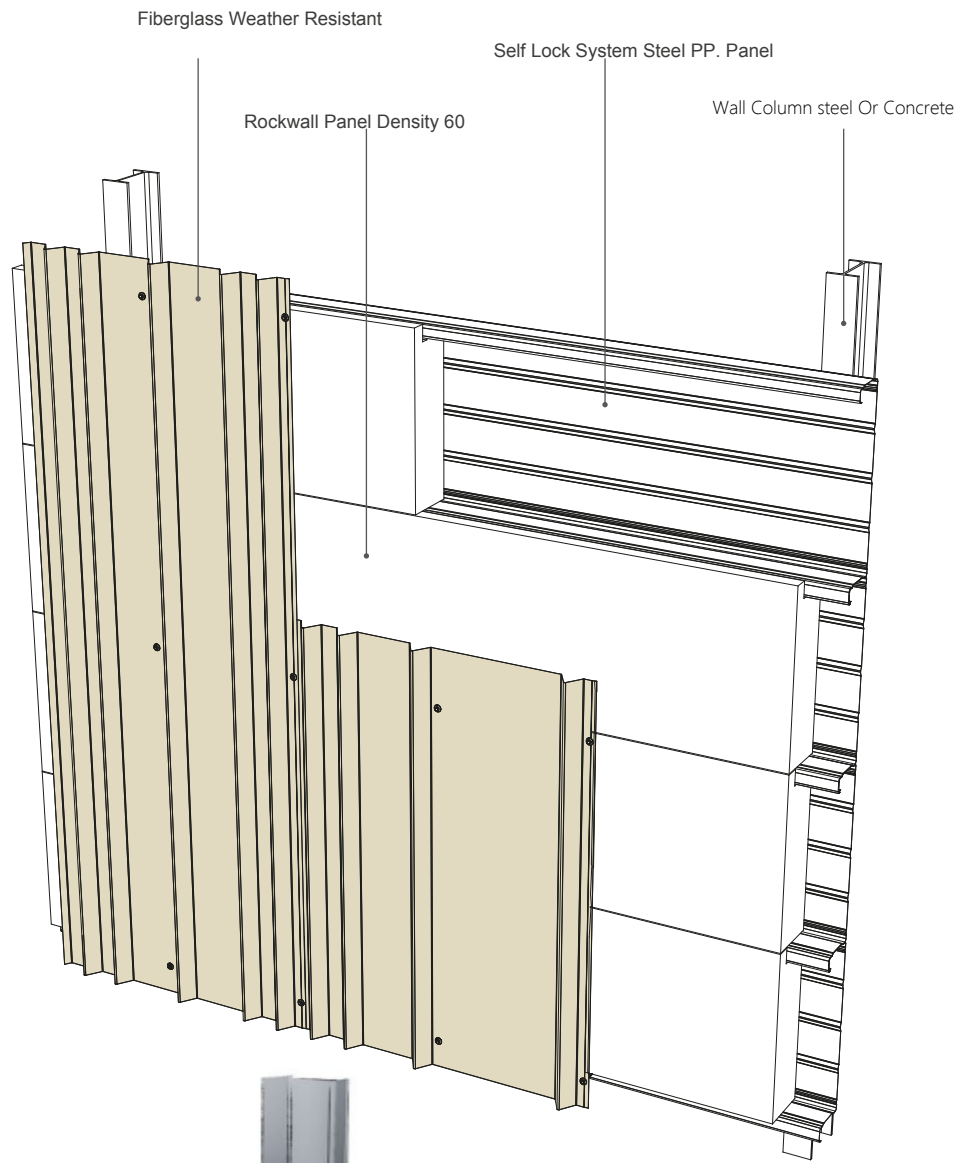



شركة المشغولات والمباني المعدنية المحدودة
STEEL BUILDING & STRUCTURE CO. LTD.

شركة ذات مسؤولية محدودة رأس المال 1.5 مليون ريال سعودي
Dammam 34331 - 4199 - Building No. 7083 - Second Industrial Area
Intersection Street 85 with 150 - Kingdom Of Saudi Arabia
CR. 2050105307 - CC. NO. 175564



+966 13 832 3388 +966 13 832 9933 alabuo@alabuo.co www.alabuo.co



BAS DE BARDAGE

PERPENDICULAIRE ET LARMIER EN POSE VERTICALE

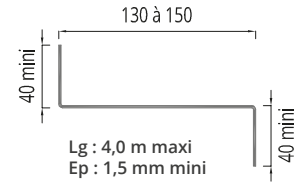
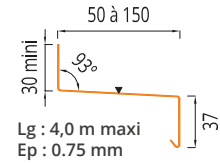
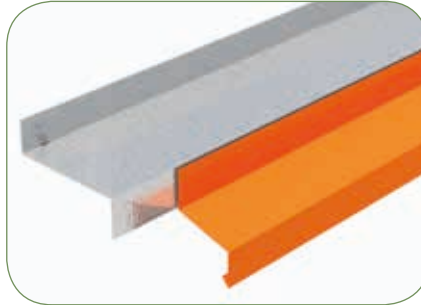
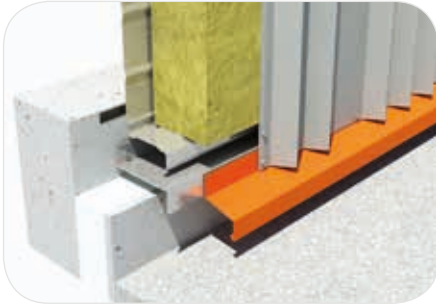

HAUT DE BARDAGE

COUVERTINE D'ACROTÈRE VISSEE EN POSE VERTICALE ET HORIZONTALE

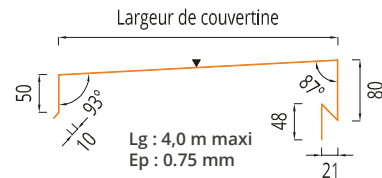
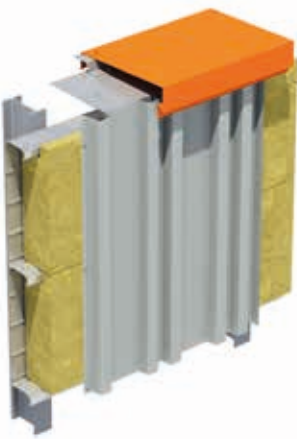

HAUT DE BARDAGE

COUVERTINE D'ACROTÈRE DÉCOUPÉE EN POSE VERTICALE

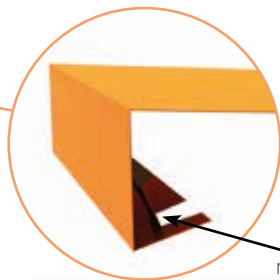
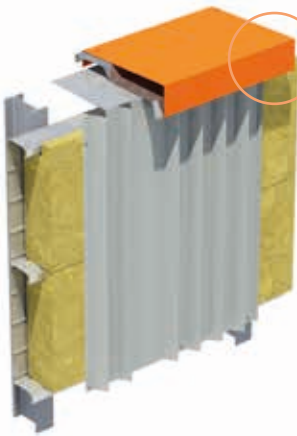

Découpe des ondes
repliée vers l'intérieur

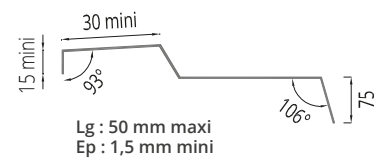
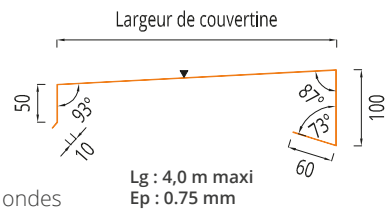

▼ Face laquée

JONCTION

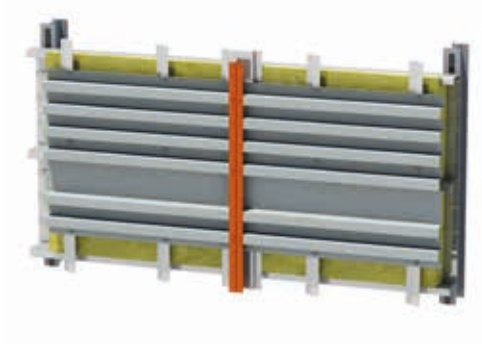

**AIGUILLE INVERSEE
EN POSE HORIZONTALE**

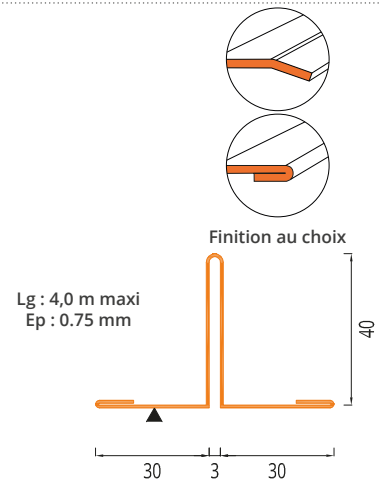

JONCTION

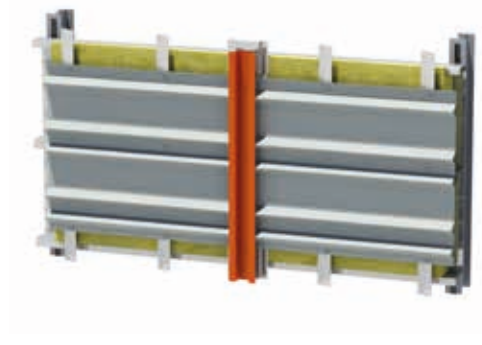

**JOINT CREUX
EN POSE HORIZONTALE**

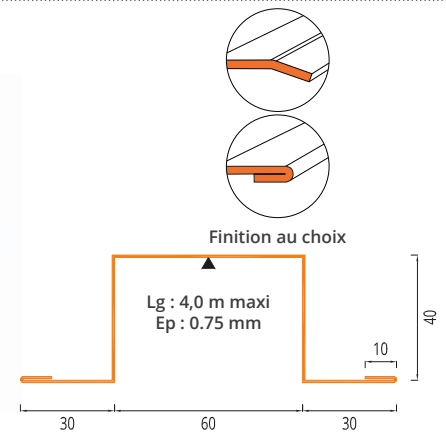

JONCTION

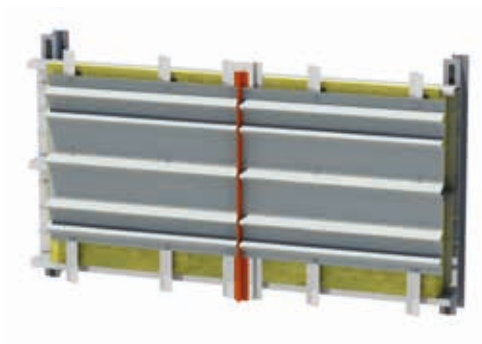

**AIGUILLE
EN POSE HORIZONTALE**

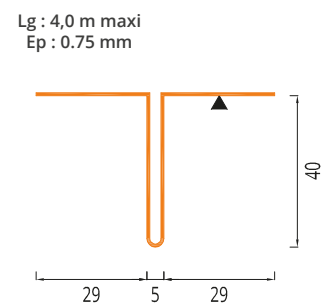

ANGLE RENTRANT

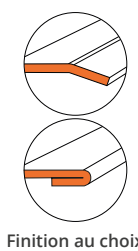
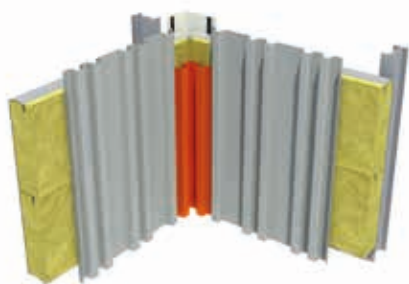

Finition au choix

ANGLE CADENCE CARRÉ EN POSE VERTICALE

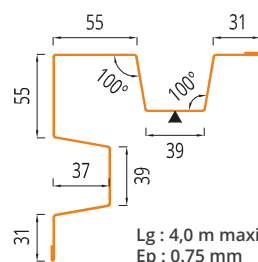

ANGLE SORTANT

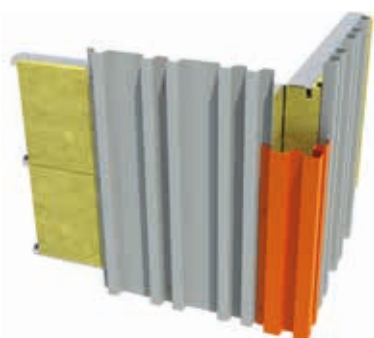

Lg : 4,0 m maxi
Ep : 0.75 mm

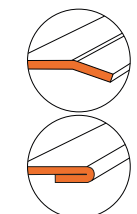
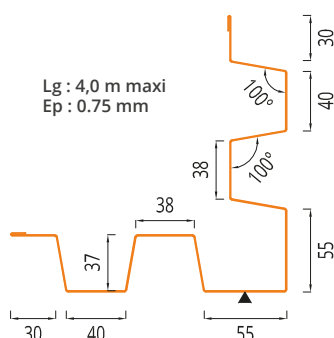

Finition au choix

ANGLE CADENCE CARRÉ EN POSE VERTICALE

ANGLE RENTRANT

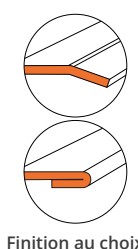
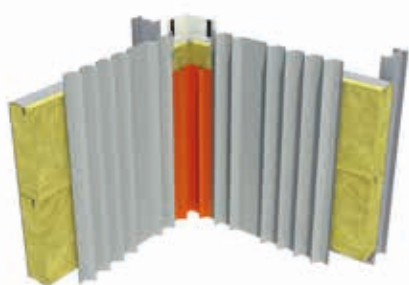

Finition au choix

ANGLE CADENCE TRIANGLE EN POSE VERTICALE

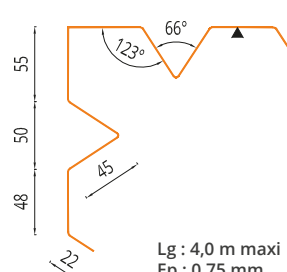

ANGLE SORTANT



Lg : 4,0 m maxi
Ep : 0.75 mm

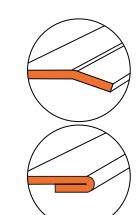
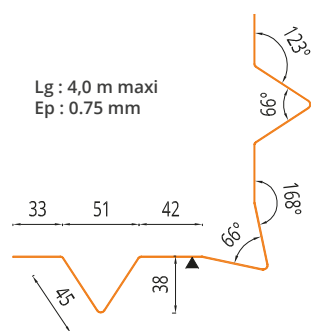

Finition au choix

ANGLE CADENCE TRIANGLE EN POSE VERTICALE

ANGLE RENTRANT



Lg : 4,0 m maxi
Ep : 0.75 mm

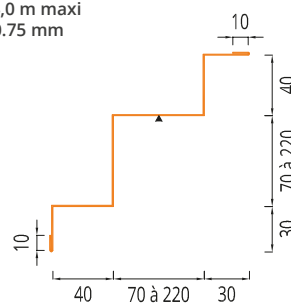

ANGLE CADENCE CARRÉ EN POSE HORIZONTALE

ANGLE SORTANT



Lg : 4,0 m maxi
Ep : 0.75 mm

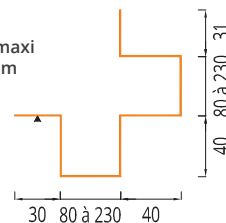

ANGLE CADENCE CARRÉ EN POSE HORIZONTALE

ANGLE RENTRANT



Lg : 4,0 m maxi
Ep : 0.75 mm

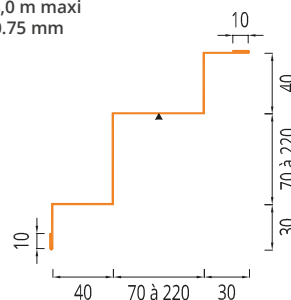

ANGLE CADENCE TRIANGLE EN POSE HORIZONTALE

ANGLE SORTANT



Lg : 4,0 m maxi
Ep : 0.75 mm

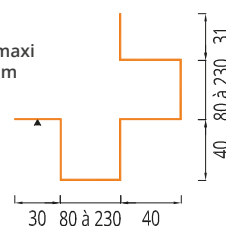

ANGLE CADENCE TRIANGLE EN POSE HORIZONTALE

SBSCO Future Wall System

Accessories

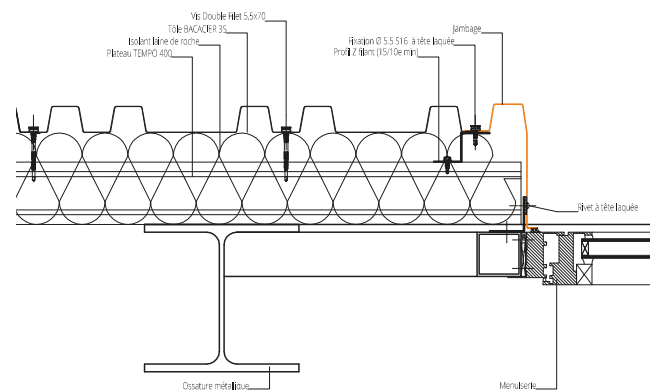
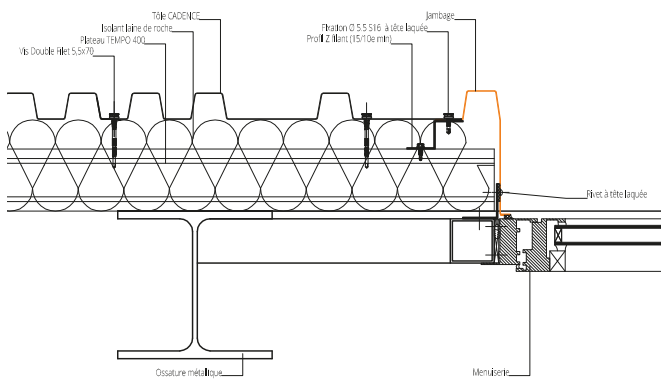
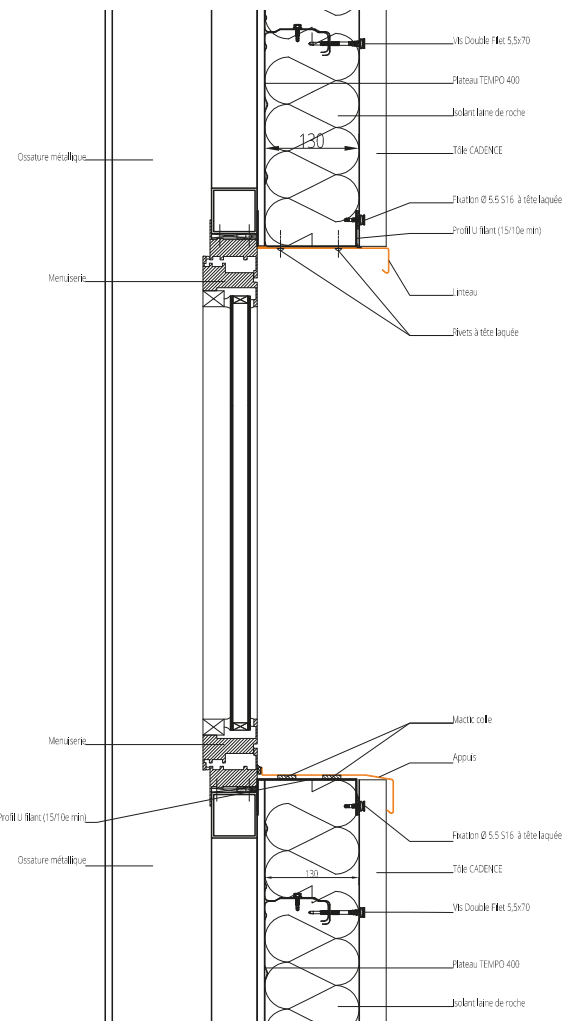

Accessories

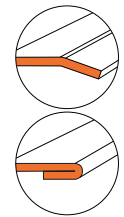
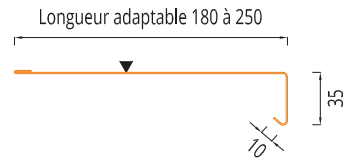

Finition au choix

Ep 0.75 mm Longueur 4 m maxi

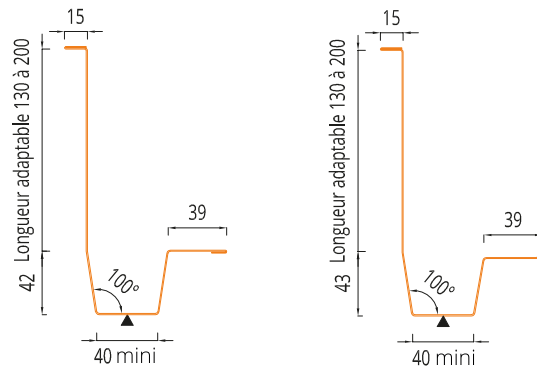
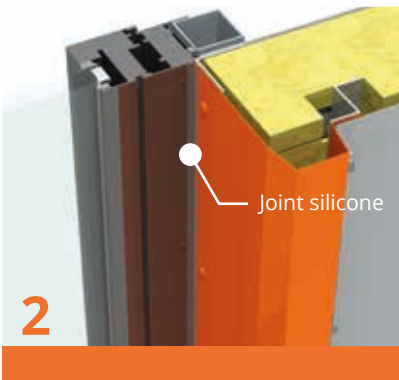

Ep 0.75 mm Longueur 4 m maxi

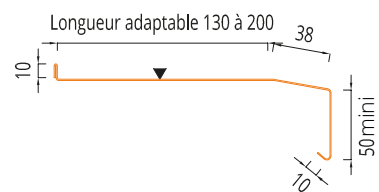
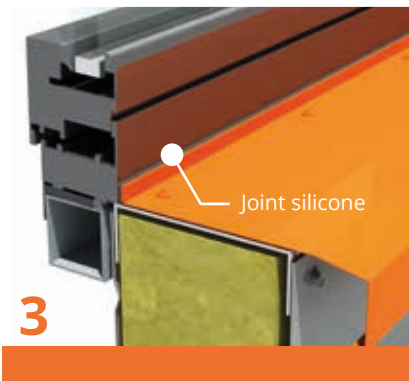

Ep 0.75 mm Longueur 4 m maxi

▼ Face laquée

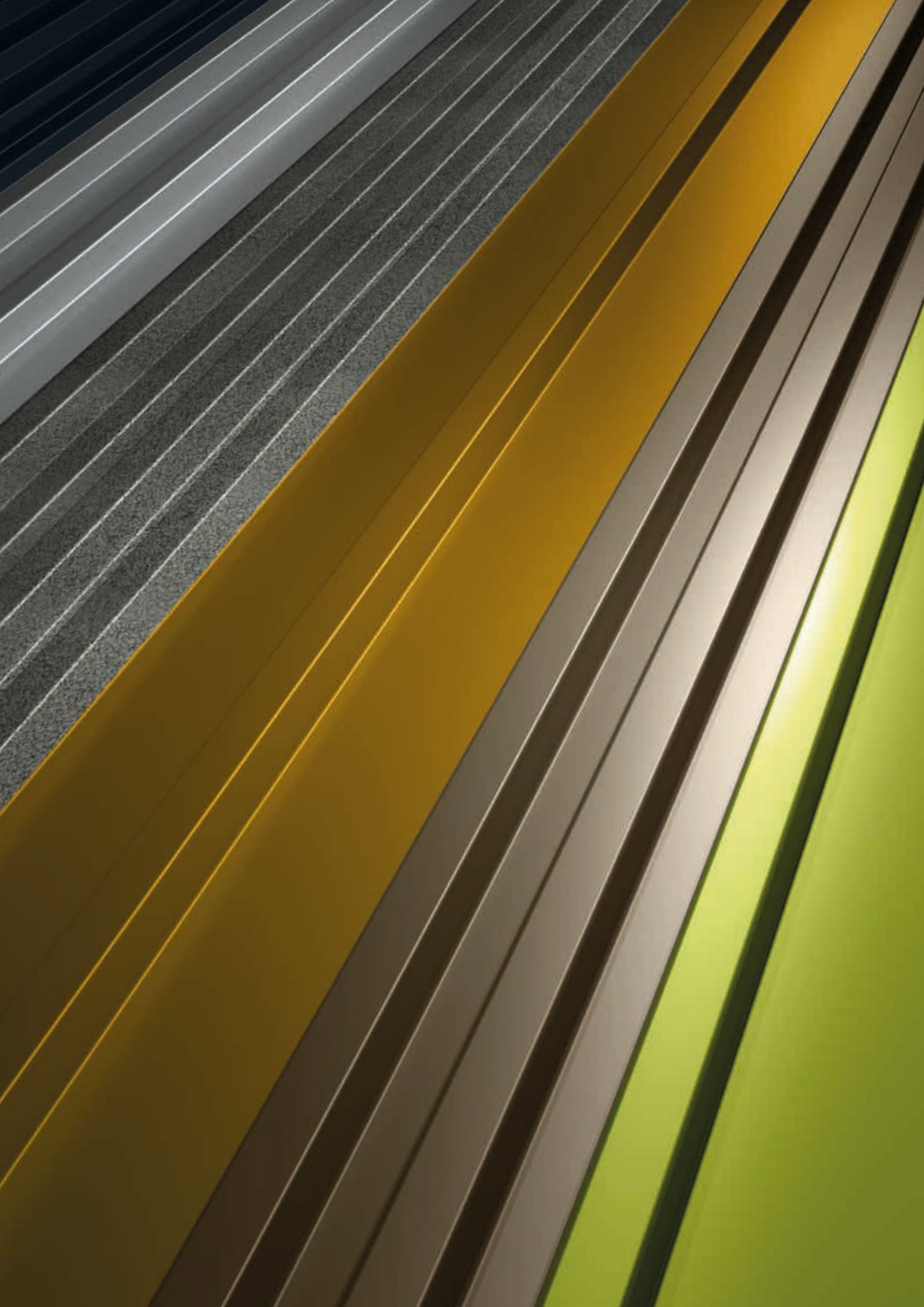

SBSCO Future Wall System



PLATINUM 0206

35 μ (métallisé)



METAL 0207

35 μ (métallisé)



PEARL 0208

35 μ (métallisé)



RAL 7022 - COQUILLE

35 μ



DUVET 0202

35 μ



POUDRE 0203

35 μ



RAL 5008 - OCEAN

35 μ



SPRING 0205

35 μ



POP 0204

35 μ

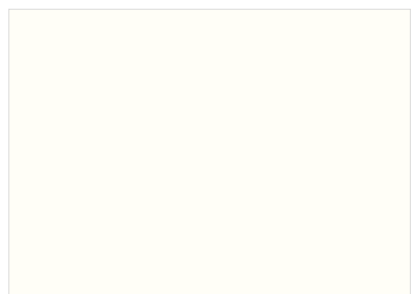

COTON 0201

35 μ

SBSCO Future Wall System



OXYDE

35μ

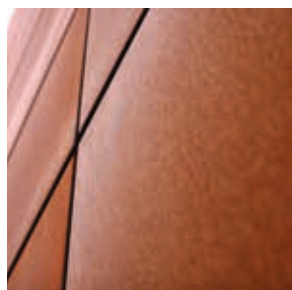

Revêtement fine texture effet rouille (aspect CORTEN)

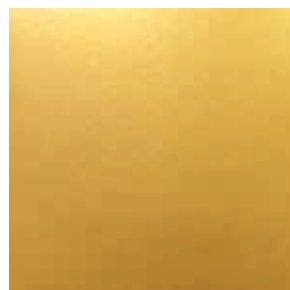

GOLD

35μ



Revêtement lisse pailleté effet or

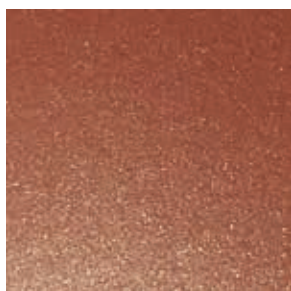

CUIVRE

35μ



Revêtement lisse pailleté effet cuivre

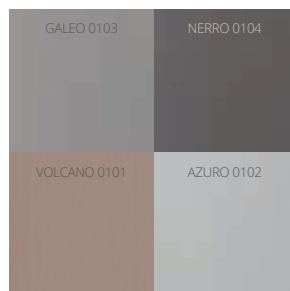

ZINC

35μ



Revêtement lisse mat effet zinc



GRANITE

35μ



Revêtement fine texture aspect pierre



QUARTZ

35μ

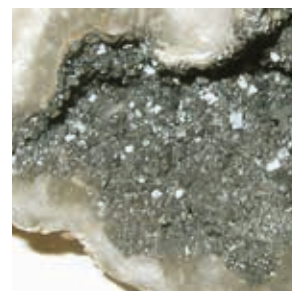

Revêtement fine texture pailleté effet Quartz

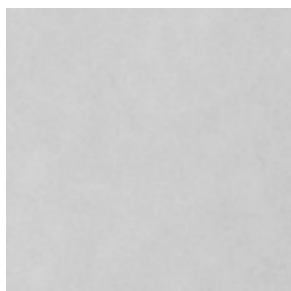

CHROME

35μ



Revêtement lisse brillant aspect chrome

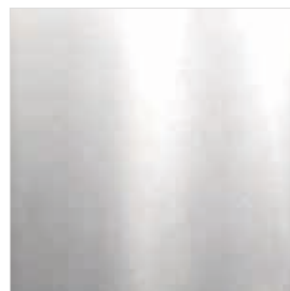

INOX

35μ



Inox véritable ep. 0.7mm finition recuit brillant

ALABUO GROUP

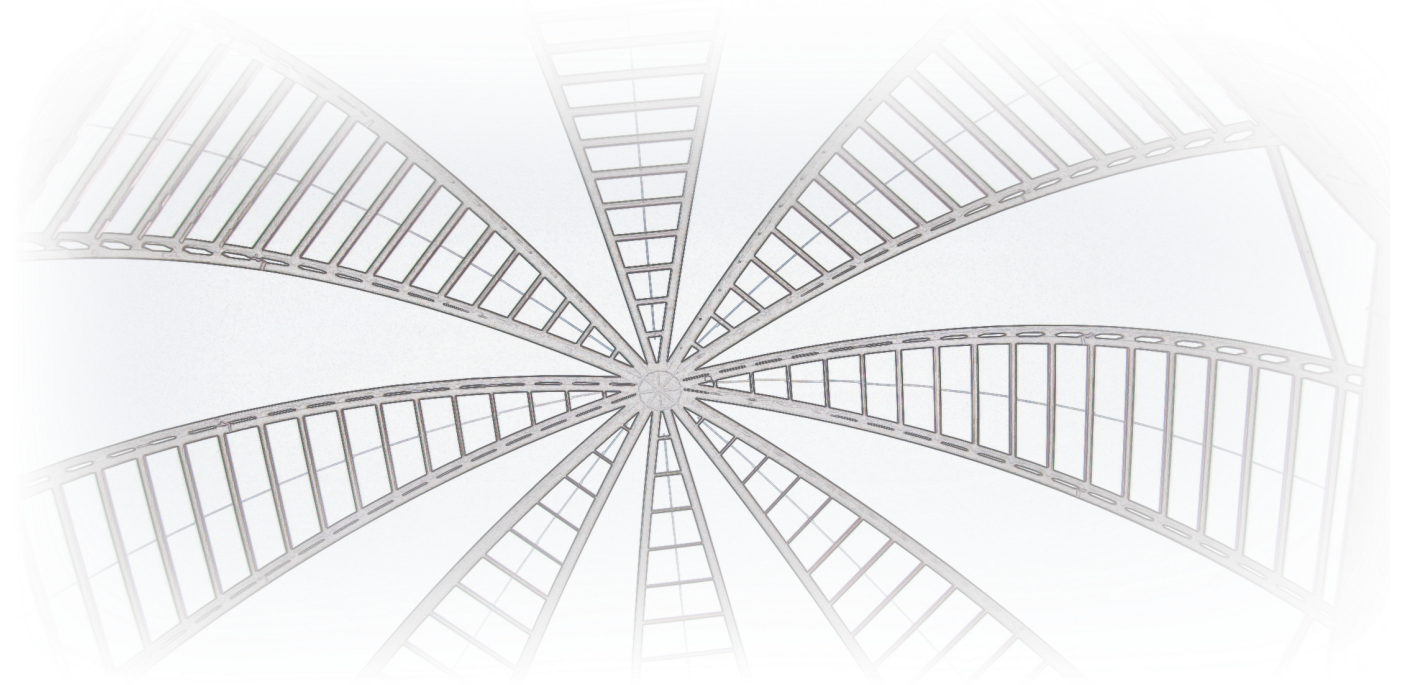

أكافي الصناعي
AKAFI.NET



شركة المشغولات والمباني المعدنية المحدودة
Steel Building & Structure Co. Ltd.



شركة الخيام والمظلات المحدودة
TENTS & AWNING CO. LTD.



شركة الشهباء للإنشاءات المحدودة
AL-Shahba For Construction Co. Ltd.

www.alabuo.com



شركة المشغولات والمباني المعدنية المحدودة
Steel Building & Structure Co. Ltd.



kingdom Of Saudi Arabia Dammam City

**Second Industrial Area - Street 85 - Building No. 7083
Zip Code 34331-4199**

www.alabuo.co

Tel : +966 13 838 3311

fax : +966 13 838 3322

alabuo@alabuo.co